



RIGEL MEDICAL

GMC-INSTRUMENTS GROUP

SafeTest 60+ USER MANUAL



rigelmedical.com

Limited Warranty & Limitation of Liability

Rigel Medical guarantees this product for a period of 1 year. The period of warranty will be effective at the day of delivery.

Calibration Statement

The Rigel SafeTest 60+ hand-held electrical safety analyzer is fully calibrated and found to be within the specified performance and accuracy at the time of production. The Seaward Group provides its products through a variety of channels, therefore, it may be possible that the calibration date on the provided certificate may not represent the actual date of first use.

Experience has indicated that the calibration of this instrument is not affected by storage prior to receipt by the user. We therefore recommend that the recalibration period be based on a 12 month interval from the first date the unit is placed in to service.

For information on service or calibration please go to the link below.

www.rigelmedical.com/calibration

© Copyright 2024

All rights reserved. Nothing from this edition may be reproduced or made public in any form either electronically, mechanically, by photocopying, recording or in any manner without prior written consent from Rigel Medical. This also applies to accompanying drawings and diagrams.

Due to a policy of continuous development Rigel Medical reserves the right to alter the equipment specification and description outlined in this publication without prior notice and no part of this publication shall be deemed to be part of any contract for the equipment unless specifically referred to as an inclusion within such contract.

Disposal of old product



The Rigel SafeTest 60+ has been designed and manufactured with high quality materials and components, which can be recycled and reused.

Please familiarise yourself with the appropriate local separate collection system for electrical and electronic products or contact your local supplier for further information.

Please dispose of this product according to local regulations. Do not dispose of this product along with normal waste material. By offering your old products for recycling, you will help prevent potential negative consequences for the environment and human health.

User Notes

These operating instructions are intended for the use of adequately trained personnel.

Environmental Conditions

The SafeTest 60+ has been designed to be operated for indoor use in a dry environment, at a temperature of 0 to 40 degrees C without moisture condensation, and at an operating altitude 0 - 2000m.

The SafeTest 60+ has a protection rating of IP40 and is rated for operation at pollution degree 2 according to IEC 60529.

The following symbols are used in these operating instructions and on the Rigel SafeTest 60+.

Safety Notes



If the SafeTest 60+ is used in a manner not specified by these operating instructions then the protection provided may be impaired.



Only accessories recommended or approved by the manufacturer should be used with the SafeTest 60+.



Do not connect the SafeTest 60+ to electrical circuits with nominal voltage greater than CAT II 300 V AC/DC.



Do not touch test probes beyond the hand barrier on the test probe.



The SafeTest 60 may apply high voltage or mains power to the appliance under test. Do not touch conductive parts of the appliance while tests are active.



Do not open the SafeTest 60+, no user serviceable parts



Do not operate the SafeTest 60+ in an explosive gas or dust environment.



The SafeTest 60+ and all associated cables and leads must be checked for signs of damage before equipment is operated. Do not use if there are signs of damage.



Where safe operation of the SafeTest 60+ is no longer possible it should be immediately shut down and secured to prevent accidental operation

It must be assumed that safe operation is no longer possible:

- if the instrument or leads show visible signs of damage or
- the instrument does not function or
- after long periods of storage under adverse environmental conditions.

To verify the correct operation of the unit, perform test functions using a known appliance or checkbox or return the unit to an approved agent for service.

1. Introduction	6
1.1. Key Features	6
1.2. Rigel SafeTest 60+ Includes	7
1.3 Interfaces	8
1.4 Optional Accessories	9
1.5 Unique use of icons	9
2. Getting Started	11
2.1 Setting your Language and Preferred Test Standard	11
2.2 Setting a Customised Limit	12
3. Earth Bond Testing	14
4. IEC 60601 Leakage Testing	16
4.1. Displaying Mains Voltage, Frequency and Load Current	18
5. IEC 62353 Leakage Testing	19
6. NFPA-99 Leakage Testing	20
7. IEC 61010 Touch Leakage & Voltage Testing	22
8. Minimise your Power Breaks in IEC 60601	24
9. Insulation Testing	25
10. Point to Point Testing	27
11. Warning Messages	29
12. About	30
13. Maintaining the Rigel SafeTest 60+	31
13.1. Cleaning the Analyzer	31
13.2. User Maintenance	31
13.3. Return Instructions	32
14. Technical Specifications	33
14.1. General Specifications	34
15. Environmental Conditions	34
Appendix A Pass / Fail Limits of IEC 60601-1	35
Appendix B Pass / Fail limits of IEC 62353	36
Appendix C Pass / Fail limits of IEC 61010	37
Appendix D IEC 60601-1 Measuring Device	37
16. Support	38
16.1. Contact Us	38

1. Introduction

The Rigel SafeTest 60+ is a robust, reliable and dedicated medical safety analyzer. It is ideal for testing high volumes of medical and laboratory equipment that does not require patient lead testing, such as beds, hoists, infusion pumps, CPAP's and centrifuges etc.

The SafeTest 60+ includes a range of safety tests to enable compliance with a range of international safety standards, including leakage testing to IEC 60601, 62353, 61010 and NFPA-99, earth bond testing to 62353, 61010 and NFPA-99, and insulation testing to IEC 62353.

The SafeTest 60+ is available in a wide range of power configurations to suit local and international markets. With a large colour display and a colour-coded user interface, it's easy to select the required tests with a single key press, whilst a fast step-through of the test routine makes the testing process speedy and dependable.

1.1. Key Features

- Compact robust and portable design
- Dynamic pass/fail thresholds
- Point-to-point insulation testing
- Patient leakage testing
- Fast step-through of test routines with minimised power breaks
- Manual control of fault conditions
- Tests to a range of international standards including IEC 60601, 62353, 61010 and NFPA-99
- Large colour display with clear read-out
- Secondary earth warnings to ensure valid test setup.
- Accurate high current. low energy earth bond testing
- Multi voltage - operates on any mains supply between 90-264V / 48-64Hz .

1.2. Rigel SafeTest 60+ Includes

- Calibration certificate
- Carry case
- Bond test probe with clip
- Detachable mains cable
- Electronic instruction manual (from website)
- Quick start guide



What's in the box?

- A** Rigel SafeTest 60+
- B** Detachable 2m mains lead
- C** Earth/ground bond test probe with clip
- D** Calibration Certificate
- E** Carry Case
- F** 5-15P to 5-15R/5-20R Plug adapter

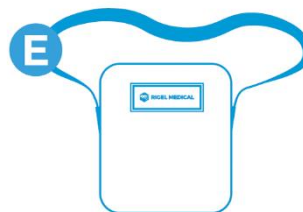
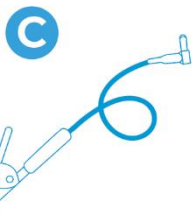
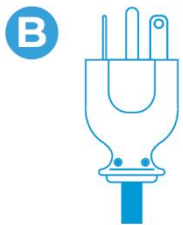

* Adapter only available in the USA

1.3 Interfaces

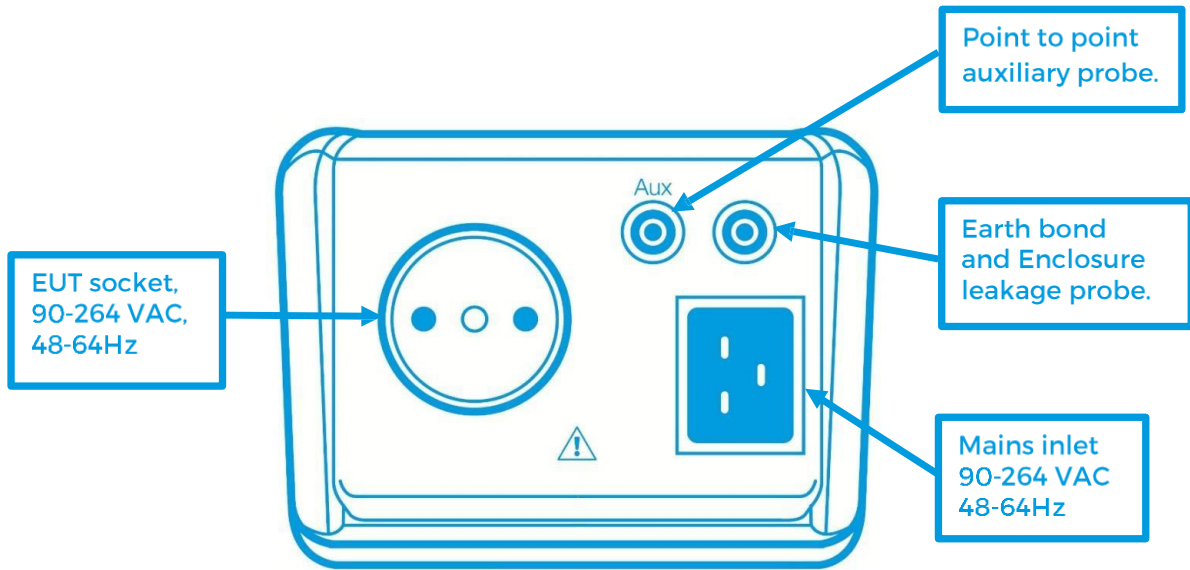

1.4 Optional Accessories

Earth bond cable	44B154
Carry case	410A950
Applied Parts Connector Box	417A911
Applied Parts Adapters	404A951

1.5 Unique use of icons

The Rigel SafeTest 60+ features a high resolution, colour graphic, back lit display, provides a unique user experience and has been designed to help guide the user through the different test steps.

Below are some of the icons used in the Rigel SafeTest 60+:



Select Earth Bond Testing



Select Leakage Testing



Select Insulation Testing



Select Point to Point Testing



Select Settings menu (Change Language & Test Standards)



Select to the Required Standard



Change to the Required Language



Product Information / Serial Number





















Confirm / OK



Display Line Voltage / Frequency & Load Current



Applies Normal Mains to EU

-  Interrupts mains to EUT
-  Applies reversed mains to the EUT
-  Warning, EUT socket live
-  Warning, 500VDC supplied to EUT
-  Select Earth leakage (in IEC60601), Ground Leakage (in NFPA 99)
-  Select Enclosure leakage (in IEC60601), Chassis Leakage (in NFPA 99)
-  Select Patient Leakage
-  Select Touch Leakage (in IEC61010 setting)
-  Select Touch Voltage (in IEC61010 setting)
-  Open **Earth** single fault condition key
-  Open **Neutral** single fault condition key
-  Earth bond test lead compensated
-  Earth bond test running
-  Return to **Home** screen
-  Select Point To Point Earth Bond Testing
-  Select Point To Point Leakage Testing
-  Select Point To Point Insulation Testing
-  Pass/Fail Limit Setting

2. Getting Started

The Rigel SafeTest 60+ is pre-programmed to perform electrical safety tests in accordance with a variety of international standards. To get started, simply follow these instructions;

Switch ON

To switch on the Rigel SafeTest 60+ please insert the mains cable to the power inlet. The SafeTest 60+ will automatically power up in the Home screen.

2.1 Setting your Language and Preferred Test Standard



From the home screen, select **Settings** to select the required language and test standard;

Press  from Home screen to enter Settings menu;

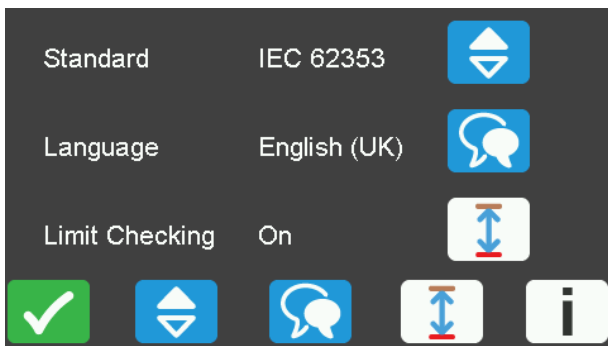

Press the  key to change to the required language

Press the  key to change to the required test standard

Press the  key to change the limit check to On/Off

Press the  key to view the firmware and hardware information

Press the  key confirm and return to the **Home menu**

Note: The Rigel SafeTest 60+ will store the most recent settings in the **Settings** menu.



From the **Home** screen, select the required test;



To select Earth Bond Testing



To select Leakage Testing



To select Insulation Testing



To select Point to Point Testing



To select Settings Menu (change Language and Test Standard)

2.2 Setting a Customised Limit

When running a test F5 will indicate the limit change icon

Press and hold down F5 then make use of the F1 key to increase your test limit value or press F2 to decrease your limit value. The limit can be changed while performing testing with one test lead or when performing Point to Point testing.

Note: The limit increase and decrease function is only operational while performing a test. When a pass is measured, the text will be green, and a symbol will display. When a fail is measured, the text will be red, and an symbol will display. The SafeTest 60+ will operate with a default limit as specified by the relevant standard or code. These default limits ensure consistent and accurate measurements according to industry regulations and guidelines.

The device will save any adjusted limit settings even during a power cycle. This means that the limits changed by the user will be retained and restored when the system is powered back on.

Earth Bond Limit Change

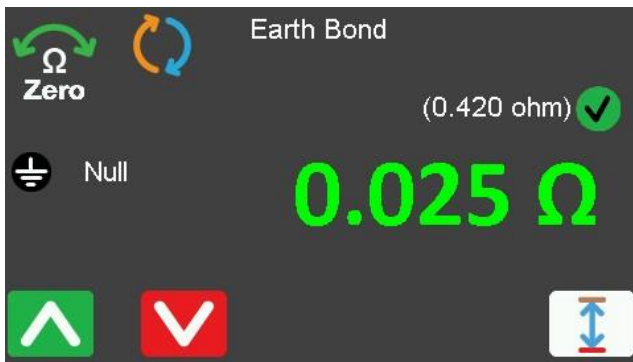

Point to Point Limit Change

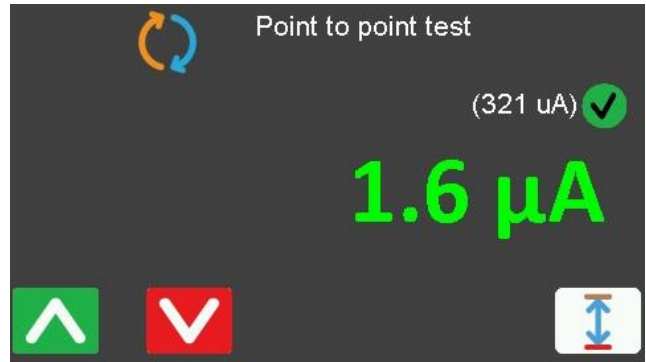

Equipment Leakage Limit Change



Insulation Point to Point Limit Change

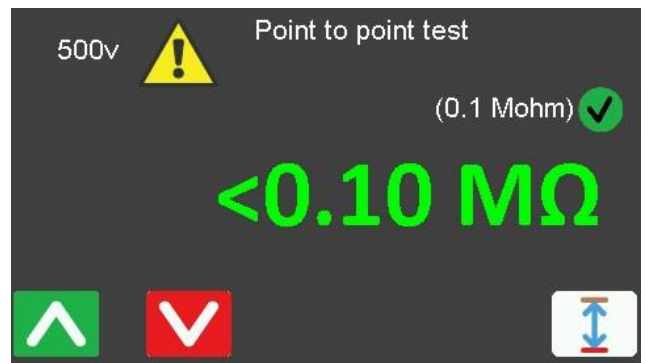

The test standard or code and the set limit will be displayed on the SafeTest 60+ screen when selecting a test.

3. Earth Bond Testing

To perform an earth bond test, select the  icon from the Home Screen



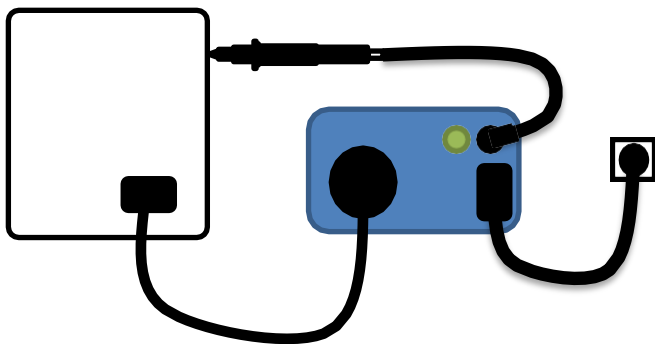

The SafeTest 60+ will automatically start the test when it is selected and will automatically stop by pressing the Leakage, Insulation or Point to Point icon.

Connection Between EUT and the SafeTest 60+ Earth Bond Testing



Note: Each time the earth bond probe is placed on a new test point, the zap circuit will be reactivated, ensuring accurate readings at every measurement point.

 Do not exceed the maximum permitted voltage of 30V AC/DC with respect to earth potential! Electric shock danger!

To compensate for the test cable resistance, connect the test cable between the black earth bond socket and the EUT earth, then press the  button on the front panel.

When the lead compensation is activated, the  icon will appear on the screen.





To remove the lead compensation, remove the probe and press the  button.

 When different earth bond cables are used, the Null function must be repeated for each different cable.

Note: Switching off the Rigel SafeTest 60+ will not cancel the 'probe zero'.

4. IEC 60601 Leakage Testing

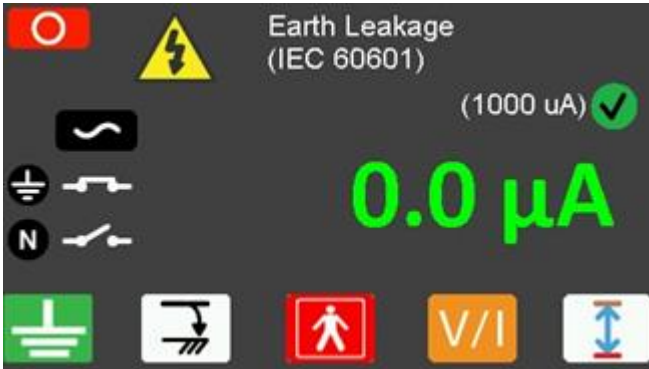

To perform an IEC 60601 leakage test, press **μA** from Home screen to enter Leakage test.

If the required test standard needs to change, please press  Home and then settings  to select the required standard.

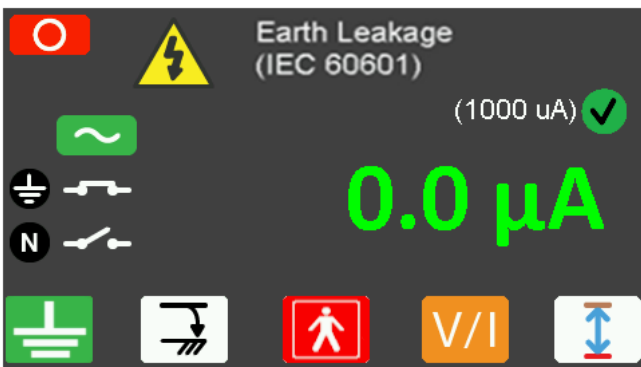

To apply mains voltage in Normal Polarity and Start the test, press the  button on the front panel. The test will run until the  button is pressed.



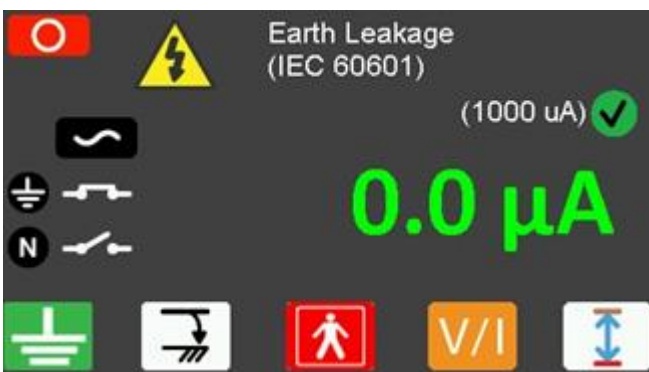

To apply mains in Reversed Polarity and Start the test, press the  button on the front panel. The test will run until the  button is pressed.

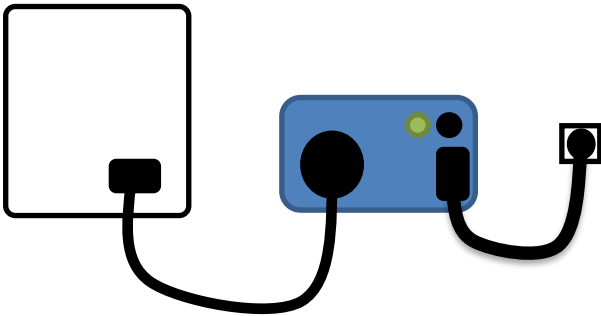

 will appear on the screen when the DUT socket is activated.

Connection Between EUT and SafeTest 60+ Earth Leakage



When the SafeTest 60+ is set to test to IEC 60601, the  will go to Enclosure Leakage and  to Earth Leakage.

To activate single fault conditions, use the  and  buttons on the front panel.  opens the Earth fault condition relay whilst the  opens the Neutral fault condition relay.

The leakage screen will indicate the current state of the selected fault conditions;

Connection Between EUT and SafeTest 60+ Enclosure Leakage

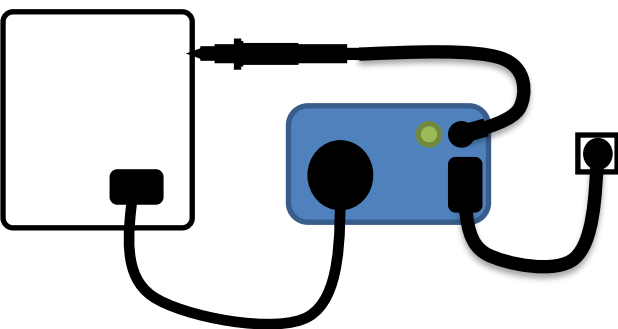

Leakage Current Type	All Applied Parts	
	NC	SFC
Earth Leakage (3rd edition)*	5mA	10mA
Earth Leakage (General)	0.5mA	1mA
Enclosure Leakage	0.1mA	0.5mA

* The pass fail limit for Earth Leakage in the 3rd edition of IEC 60601 has been increased from 500µA under normal condition to 5000µA for class I equipment with NO exposed metal parts that may become live when a fault appears.

4.1. Displaying Mains Voltage, Frequency and Load Current

During a leakage test, the mains voltage, frequency and load current can be displayed by pressing the .

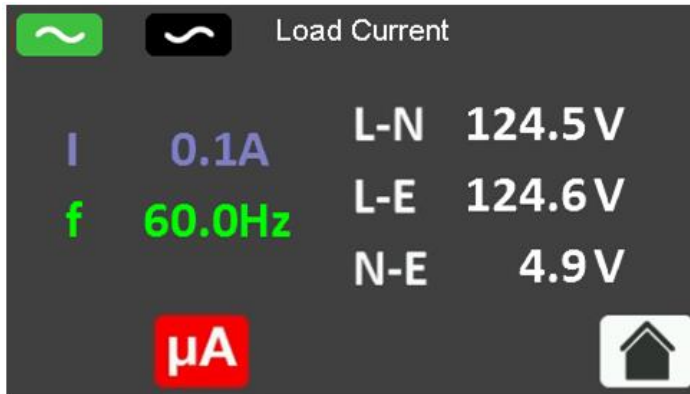

5. IEC 62353 Leakage Testing

To perform an IEC 62353 leakage test, press **μA** from Home screen to enter Leakage test. If the required test standard needs to change, please press  Home and see Setting your Language and Preferred Test Standard.





To apply mains voltage in **Normal Polarity** and START the test, press the  button on the front panel. The test will run until the  button is pressed.

To apply mains in **Reversed Polarity** and START the test, press the  button on the front panel. The test will run until the  button is pressed.

To minimise the power breaks during your tests, please see Minimise your Power Breaks in IEC 60601.



 will appear on the screen when the DUT socket is activated.

When the SafeTest 60+ is set to test to IEC 62353, the Single Fault buttons  and  deactivated in order to perform the test as per IEC 62353 requirements.

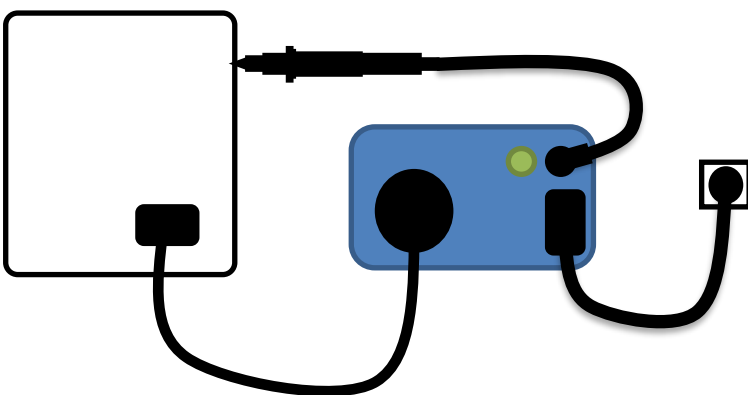
Connection Between EUT and SafeTest 60+ Equipment Leakage IEC 62353



6. NFPA-99 Leakage Testing

To perform an NFPA-99 leakage test, select the NFPA 99 standard from the settings menu then press  to save. Press  from Home screen to enter Leakage test. 

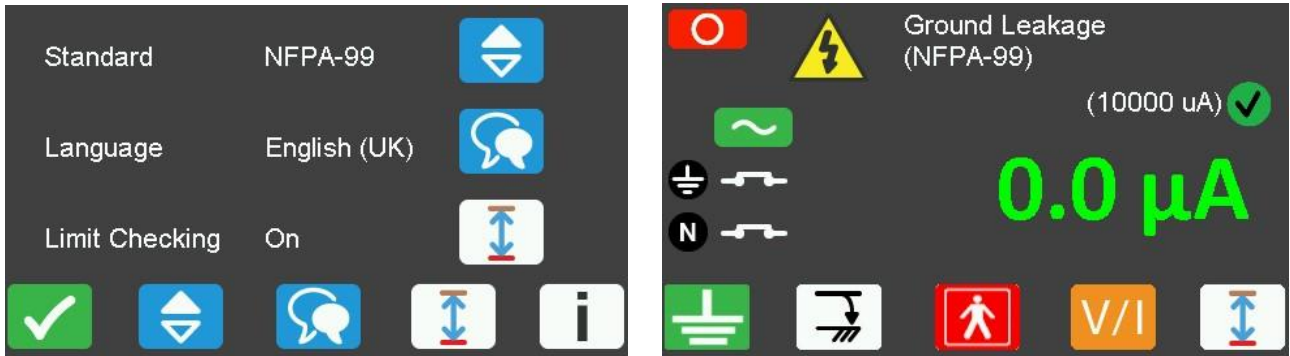



To apply mains voltage in Normal Polarity and START the test, press the  button on the front panel. The test will run until the  button is pressed.

To apply mains in Reversed Polarity and START the test, press the  button on the front panel. The test will run until the  button is pressed.



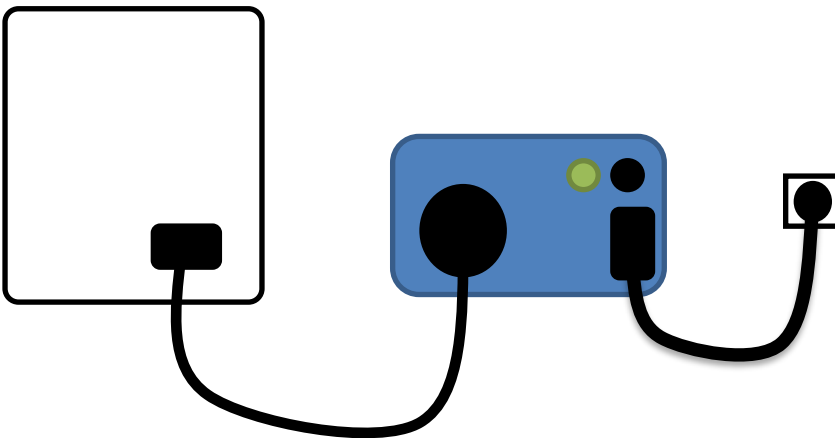

 will appear on the screen when the DUT socket is activated.

Connection Between EUT and SafeTest 60+ Ground Leakage NFPA-99

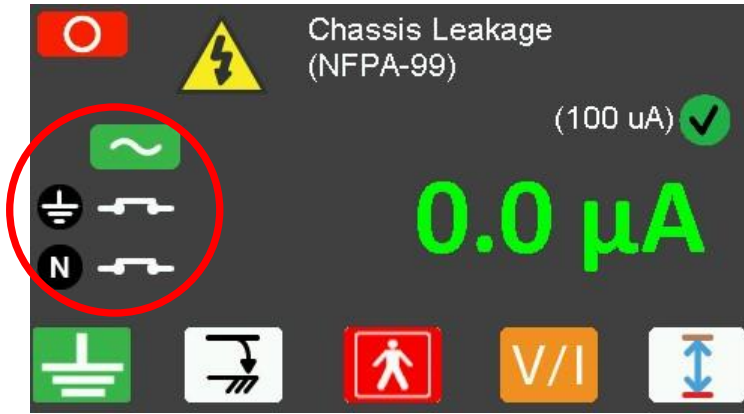

When the SafeTest 60+ is set to test to NFPA-99, the  will go to Chassis leakage and  to Ground leakage.



To activate single fault conditions, use the  and  buttons on the front panel.  opens the Earth fault condition relay whilst the  opens the Neutral fault condition relay.

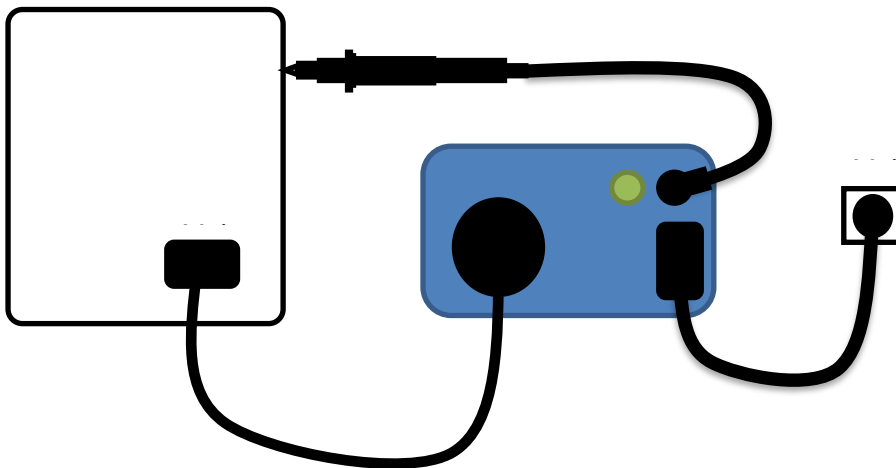

The leakage screen will indicate the current state of the selected fault conditions;

Connection Between EUT and SafeTest 60+ Chassis Leakage NFPA-99



	For All Applied Parts	
Leakage Current Type	NC	SFC
Ground Leakage	0.3mA	1mA
Chassis Leakage	0.1mA	0.5mA

7. IEC 61010 Touch Leakage & Voltage Testing

To perform an IEC 61010 touch leakage test, select the IEC61010 standard from the settings  menu then press  to save. Press  from Home screen to enter Leakage test.

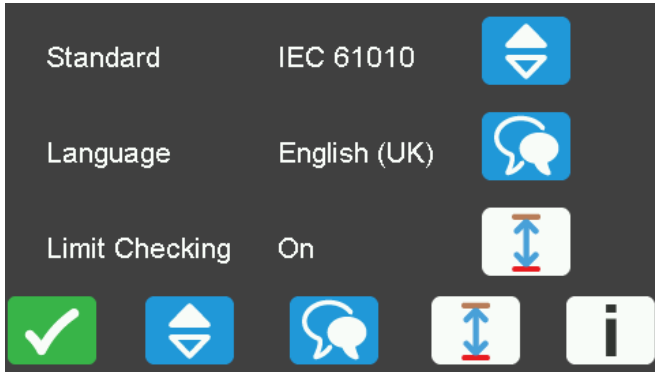

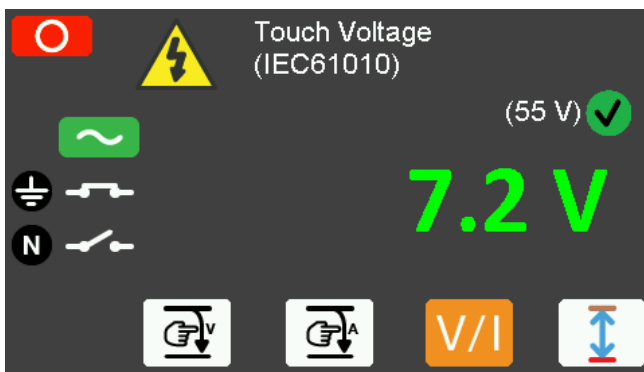

To apply mains voltage in **Normal Polarity** and START the test, press the  button on the front panel. The test will run until the  button is pressed.



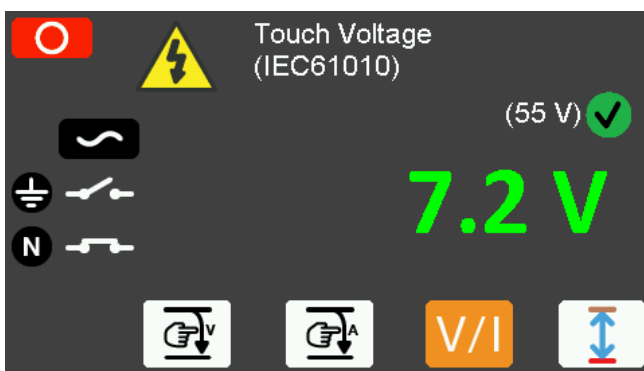



To apply mains in **Reversed Polarity** and START the test, press the  button on the front panel. The test will run until the  button is pressed.

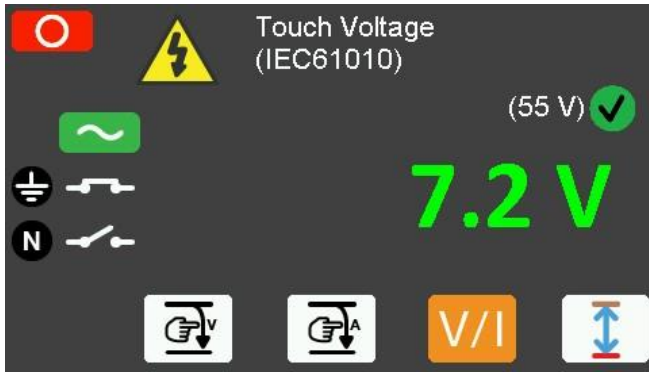

 will appear on the screen when the DUT socket is activated.

When the SafeTest 60+ is set to test to IEC 61010, the  will go to Touch Voltage and  to Touch Leakage.



To activate single fault conditions, use the  and  buttons on the front panel.  opens the Earth fault condition relay whilst the  opens the Neutral fault condition relay.

The leakage screen will indicate the current state of the selected fault conditions.



Connection Between EUT and SafeTest 60+ Touch Leakage and Touch Voltage IEC 61010

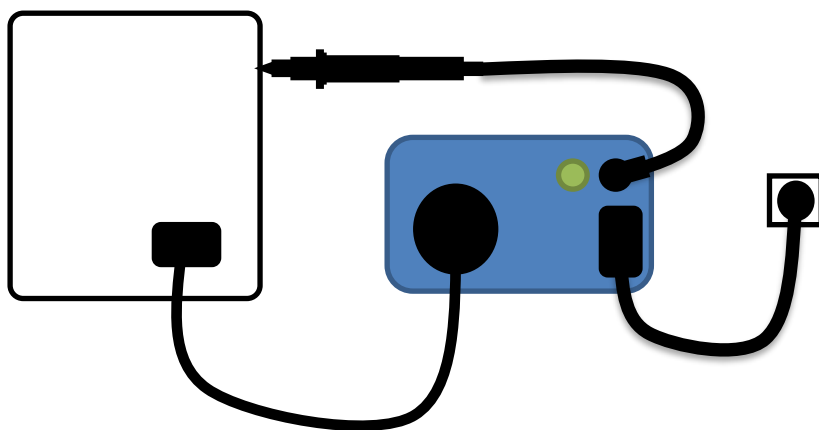

IEC 61010 Tests		
Tests	NC	SFC
Touch Leakage	0.5mA	3.5mA
Touch Voltage	33V	55V

8. Minimise your Power Breaks in IEC 60601

Certain medical equipment can be sensitive to sudden power breaks or have a long power-up cycle. To protect your equipment or to reduce the overall test time, we suggest you run the SafeTest 60+ in the following sequence;

To minimise the power breaks to the EUT, all leakage measurements should be grouped by Single Fault Condition (SFC).

As such, all leakage measurements are carried out for a specific SFC, leakage measurements are then repeated for the next SFC. This is to minimise the power breaks and power ups.

Normal Polarity Testing – Power Up

1. Earth Leakage Normal Supply
2. Enclosure Leakage Normal Supply, Earth CLOSED
3. Enclosure Leakage Normal Supply, Earth OPEN

Normal Polarity Testing – Power Down

4. Enclosure Leakage Normal Supply, Neutral OPEN
5. Earth Leakage Normal Supply, Neutral OPEN

Reversed Polarity Testing – Power Up

6. Earth Leakage Reversed Supply
7. Enclosure Leakage Reversed Supply, Earth CLOSED
8. Enclosure Leakage Reversed Supply, Earth OPEN

Reversed Polarity Testing – Power Down

9. Enclosure Leakage Reversed Supply, Neutral OPEN
10. EARTH LEAKAGE Reversed Supply, Neutral OPEN

Below is a graph highlighting the Grouping of Single Fault Conditions () and the delays which are manually controlled by the User (t_a , t_b , t_c & t_d) and the time in which the safety analyzer performs the automatic test routines.

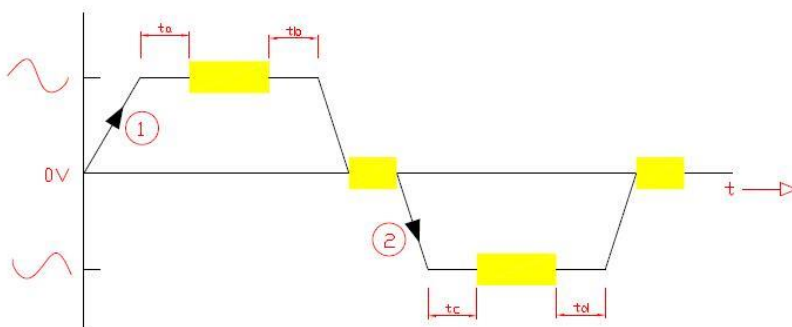

9. Insulation Testing

To perform an insulation test, press **MΩ** from Home screen.



The SafeTest 60+ will automatically start the test and will automatically stop by pressing the Earth bond, Leakage, Insulation, Point to Point or Home icon.

 During this test, 500V D.C. is applied between the black socket on the back panel as well as earth pin in the EUT socket and both the live and neutral pins of the EUT.

The Insulation Voltage will be applied between L-N to Earth for class 1 equipment or L-N to the black socket for class 2 equipment.

Connection Between EUT and SafeTest 60+ Insulation Testing IEC 62353

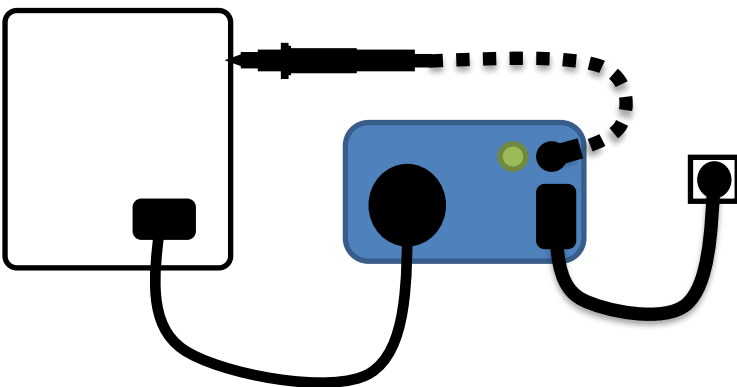

 Do not exceed the maximum permitted voltage of 30 V AC/DC with respect to earth potential! Electric Shock danger!

 Do not connect any probe combination to voltages in excess of 30 V AC/DC with respect to earth potential when performing non-power tests. This can cause damage to the equipment.

Insulation Test	B	BF	CF
Class I (MAINS to PE)	>2MΩ	>2MΩ	>2MΩ
Class I & II (MAINS to ACCESSIBLE CONDUCTIVE PARTS)	>7MΩ	>7MΩ	>7MΩ
Class I & II (PE to ACCESSIBLE CONDUCTIVE PARTS)	>70MΩ	>70MΩ	>70MΩ
Class I & II (AP to ACCESSIBLE CONDUCTIVE PARTS)	>70MΩ	>70MΩ	>70MΩ
Class I (MAINS to AP)	>2MΩ	>70MΩ	>70MΩ
Class II (MAINS to AP)	>7MΩ	>70MΩ	>70MΩ

10. Point to Point Testing

To perform a Point to Point test, press  from Home screen. Select Earth bond/ground  (F1), Leakage  (F2) or Insulation  (F3) to perform a test.

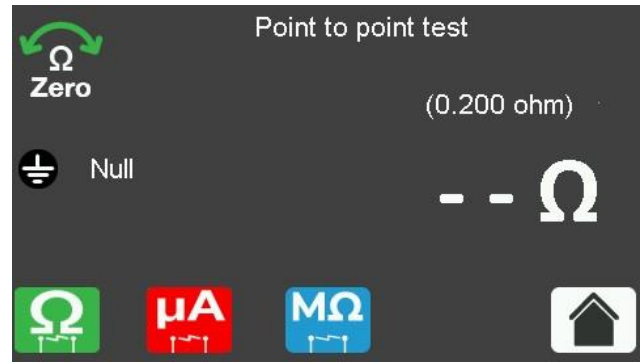

Select  to perform a Point to Point earth bond test.

Select the limit  (F4) to alter the Pass/Fail limits while testing.



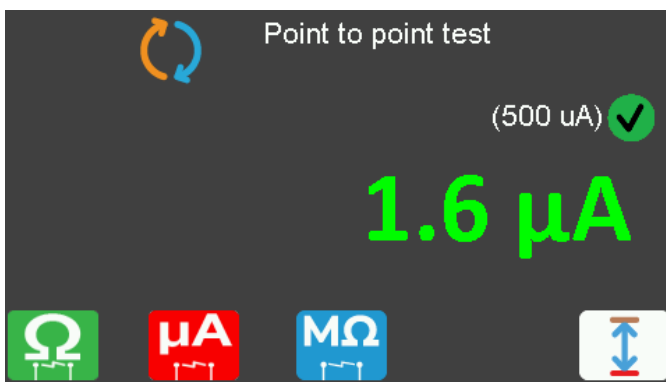

Select  to perform a point to point leakage test.

Select the limit  to alter the Pass/Fail limits while testing

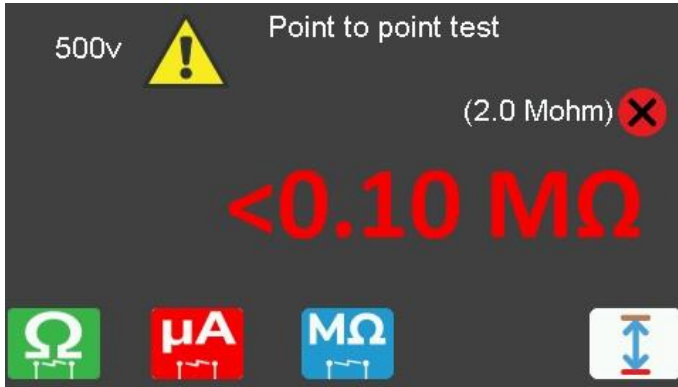

Select  to perform an insulation test. When selecting the point-to-point insulation test, a 3-second delay will occur before 500V is applied to the ports to ensure safety.



Select the limit  (F4) to alter the Pass/Fail limits while testing.

Select  to exit the point to point function and return to the Home screen.

Connect the Point to Point probes between the BLACK and GREEN socket on the back panel. The EUT socket will power up during leakage tests however the mains cable is not part of the measurement circuit hence it is shown as optional and not required.

Connection Between EUT and SafeTest 60+ Point to Point Testing

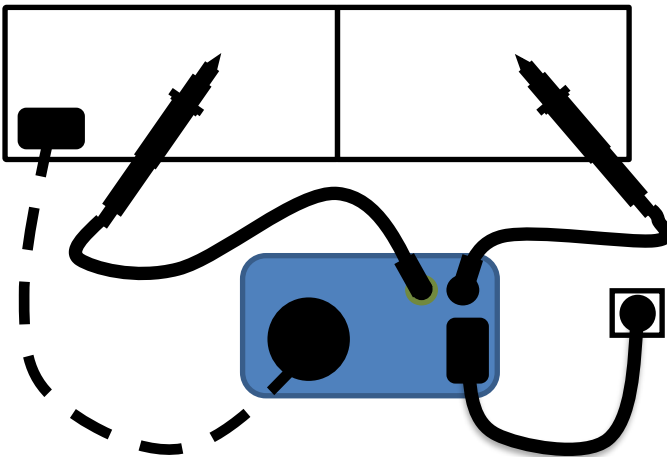

11. Warning Messages

The Rigel SafeTest 60+ will automatically warn the user of possible incorrect test setups such as secondary earthing and isolated mains supply (mains voltage isolated from earth).

Secondary Earth Warning:

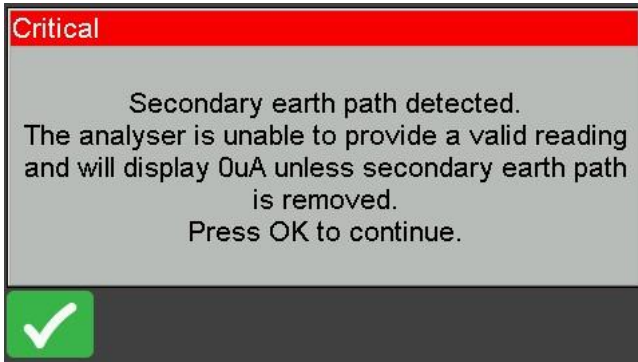

To perform a valid test, the secondary earth must be removed. Testing with a secondary earth will lead to invalid readings as the leakage current will flow through the low resistance secondary earth rather than the high resistance (1kΩ) body model in the Safetest 60+.

Isolated Earth Error:

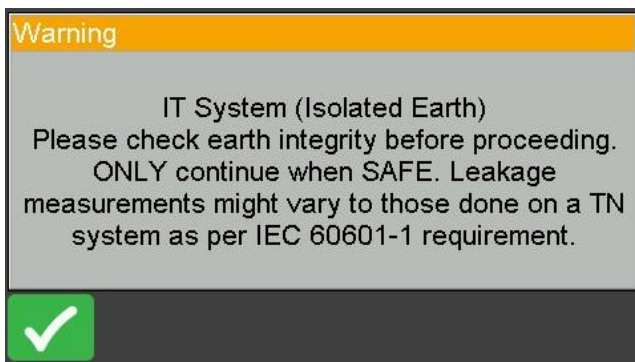

Please note that leakage values can appear at half the value as would be expected under a normal mains configuration.

12. About

From the Home screen, select Settings, then the  key to view the firmware and hardware information.

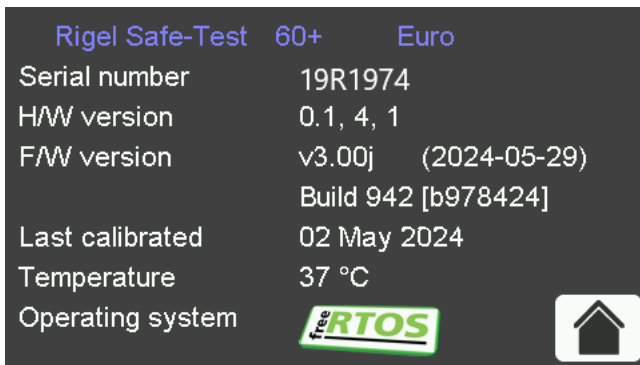

- Firmware version
- Serial Number

Ensure you have this information available when contacting Rigel Medical for Technical Support or Service.

13. Maintaining the Rigel SafeTest 60+

13.1. Cleaning the Analyzer

The Rigel SafeTest 60+ case can be cleaned with a damp cloth with, if necessary, a small amount of mild detergent. Prevent excessive moisture around the socket panel or in the lead storage area.

Do not allow liquid inside the Rigel SafeTest 60+ or near the sockets. Do not use abrasives, solvents or alcohol.

If any liquid is spilt into the Rigel SafeTest 60+ case, the Analyzer should be returned for repair, stating the cause of the defect.

13.2. User Maintenance

The Rigel SafeTest 60+ is a rugged quality instrument. However, care should always be taken when using, transporting and storing this type of equipment. Failure to treat the product with care will reduce both the life of the instrument and its reliability.

If the Rigel SafeTest 60+ is subject to condensation, allow the Analyzer to completely dry before use.

- Always check the Rigel SafeTest 60+ and all test leads for signs of damage and wear before use.
- Do not open the Rigel SafeTest 60+ under any circumstances.
- Keep the instrument clean and dry.
- Avoid testing in conditions of high electrostatic or electromagnetic fields.
- Maintenance should only be performed by authorised personnel.
- There are no user replaceable parts in the Rigel SafeTest 60+.
- The unit should be regularly calibrated (at least annually).

13.3. Return Instructions

Prior to returning your unit for service, please contact our service department to obtain a Returns Number.

By obtaining a Returns Number, your service request can be booked in advance thus reducing the down time of your equipment.

When asking for a Returns Number, please quote:

- Instruments name and model
- Serial number (see section 12)
- Firmware version (see section 12)

Service, Calibration and Repair

Tel: +44 (0) 191 587 8739

Fax: +44 (0) 191 518 4666

Email: service@calibrationhouse.com

Calibrationhouse
11 Bracken Hill
South West Industrial Estate
Peterlee, County Durham
SR8 2SW, United Kingdom

Service, Calibration and Repair (USA ONLY)

Tel: +1 813 886 2775

Fax: +1 813 886 2754

Email: usaservice@calibrationhouse.com

Seaward Group USA
6304 Benjamin Road
Suite 506
Tampa, FL 33634
United States

14. Technical Specifications

Earth Continuity

Pre-pulse	65-25A peak current, (0.1 to 0.8Ω respectively)
Pulse Shape	Exponential Decay
Decay Time	200 – 550μs to 5% of peak current, (0.1 to 0.8Ω respectively)
Method	2 wire,
Measurement Current	>± 200mADC into 2Ω
Max Test Voltage	4-24Vrms o/c
Measuring Range (Low Range)	0.001 – 0.999Ω
Resolution	0.001Ω
Measuring Range (Mid Range)	1.00 – 9.99Ω
Resolution	0.01Ω
Measuring Range (High Range)	10.0 – 19.9Ω
Resolution	0.1Ω
Accuracy	± 1% of value, ± 5mΩ ± 1% of value, ± 5mΩ
Circuit Protection	Test inhibited if ≥ 30VAC or DC at 4mm inputs

Insulation Resistance

Measurement	Point-to-point and EUT to Earth
Voltage	500VDC @1mA
Maximum O/C Voltage	<600VDC
Range	100K – 100MΩ ± 5% ± 2 Digits
Resolution	0.01MΩ
Short Circuit Current	<2mA

Powered Leakage Measurements

IEC 62353	Equipment Leakage (Direct)
IEC / AAMI 60601	Earth + Enclosure Leakage + Patient Leakage
NFPA-99	Ground + Chassis Leakage + Patient Leakage
IEC 61010	Touch Leakage, Touch Voltage
Test Voltage	Mains Supply Voltage
Measuring Range	0.1 - 9999μA (0.1 - 8000μA typical for IEC61010)
Measurement/Display Resolution	0.1 μA
Accuracy	± 2%, ± 5 μA
Mains Reversal	Soft Key
Single Fault Conditions	Open Neutral and Open Earth Via Soft Key
Frequency Response	IEC 60601 – 62353, NFPA-99, and IEC 61010 selectable

Voltage Measurement

Application	L-N, L-E, N-E and touch voltage (IEC 61010)
Range	0.0V – 300VAC
Resolution	0.1V
Accuracy	± 2% ± 5 digits (between 10V – 270VAC)
Mains frequency	45.0 – 66.0Hz
Resolution	0.1Hz
Accuracy	Unspecified

EUT Load Current Measurement

Range	0.0A – 20.0A
Resolution	0.1A
Accuracy	±5% ± 2 digits

Power Source

Maximum Current Rating	20A @ 120V / 16A @ 230V
Duty cycle (@21°C ambient)	16A to 20A, 3 min. on/ 10 min. off 10A to 15A, 3 min. on/ 5 min. off 0A to 10A, continuous
Mains Power	90-264V 48-64Hz

14.1. General Specifications

Weight	1.1kg/2lbs (unit) 2.2kg/5lbs (complete with accessories)
Size (L x W x D)	225 x 150 x 100mm / 9 x 6 x 4"

15. Environmental Conditions

Operating Temperature	0 to 40°C
Humidity	0 -98% Relative humidity, non-condensating
Storage Temperature	-10 to 50°C
Altitude	0 – 2000m
Ingress Protection	IP 40
Operating Pollution Degree	2, according to IEC 60529
Overvoltage Category	CAT II 300V

Appendix A Pass / Fail Limits of IEC 60601-1

Earthbond test limit at 25A, 50Hz	
Excluding power cord	< 0.1 Ω
Including power cord	< 0.2 Ω

Leakage Current Type	Type B Applied Parts		Type BF Applied Parts		Type CF Applied Parts	
	NC	SFC	NC	SFC	NC	SFC
Earth Leakage (3rd edition)*	5000 μ A	10000 μ A	5000 μ A	10000 μ A	5000 μ A	10000 μ A
Earth Leakage (General)	500 μ A	1000 μ A	500 μ A	1000 μ A	500 μ A	1000 μ A
Enclosure Leakage	100 μ A	500 μ A	100 μ A	500 μ A	100 μ A	500 μ A
Patient Leakage (dc)	10 μ A	50 μ A	10 μ A	50 μ A	10 μ A	50 μ A
Patient Leakage (ac)	100 μ A	500 μ A	100 μ A	500 μ A	10 μ A	50 μ A
Patient Leakage (F-Type)	NA	NA	NA	5000 μ A	NA	50 μ A
Patient Leakage (Mains on SIP/SOP)	NA	5mA	NA	NA	NA	NA
Patient Auxiliary Current (dc)	10 μ A	50 μ A	10 μ A	50 μ A	10 μ A	50 μ A
Patient Auxiliary Current (ac)	100 μ A	500 μ A	100 μ A	500 μ A	10 μ A	50 μ A

* The pass fail limit for Earth Leakage in the 3rd edition of IEC 60601 has been increased from 500 μ A under normal condition to 5000 μ A for class I equipment with NO exposed metal parts that may become live when a fault appears.

Appendix B Pass / Fail limits of IEC 62353

Earthbond test limit at 200mA AC or DC	
Excluding Power Cord	< 0.2 Ω
Including Power Cord	< 0.3 Ω

Current in μA (RMS)	Applied Part		
	Type B	Type BF	Type CF
Equipment Leakage – Alternative Method			
Class I Equipment	1000μA	1000μA	1000μA
Class II Equipment	500μA	500μA	500μA
Equipment Leakage – Direct or Differential Method			
Class I Equipment	500μA	500μA	500μA
Class II Equipment (touch current)	100μA	100μA	100μA
Patient Leakage Current – Alternative Method (a.c.)			
Class I & II		5000μA	50μA
Patient Leakage Current – Direct Method (a.c.)			
Class I & II		5000μA	50μA

Note 1: This IEC 62353 standard does not provide measuring methods and allowable values for equipment producing d.c. leakage currents. In such a case the manufacturer should give information in accompanying documents.

Note 2: Particular standards may allow different values of leakage current

Appendix C Pass / Fail limits of IEC 61010

Earthbond test limit (no current specified in 61010)	
Including power cord	< 0.2 Ω

Tests	NC	SFC
Touch Leakage	500µA	3500µA
Touch Voltage	33V	55V

Appendix D IEC 60601-1 Measuring Device

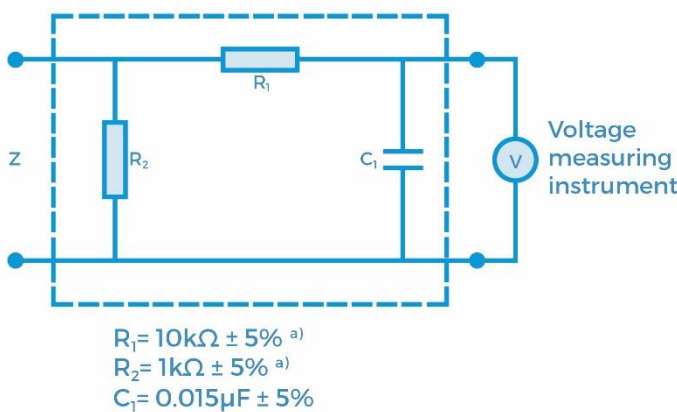

a) Measuring device

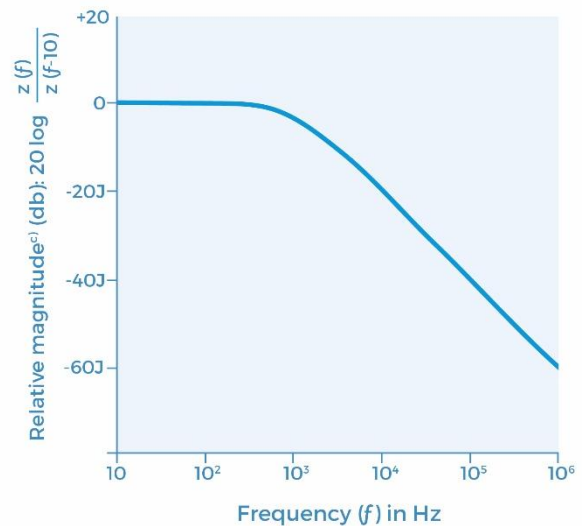

b) Frequency characteristics

Note: The network and voltage measuring instrument above are replaced by the symbol  in the following figures:

- a) Non-inductive components
- b) Impedance >> measuring impedance Z
- c) Z (f) is the transfer impedance of the network, i.e. V_{out}/I_{in} , for a current frequency f

Example of a measuring device MD according to IEC 60601-1 and its frequency characteristics.

16. Support

16.1. Contact Us

Sales and Delivery enquiries

Tel: +44 (0) 191 586 3511

Email: sales@rigelmedical.com

Technical enquiries

Please go to rigelmedical.com/support and raise a support ticket for your enquiry.

Service, Calibration and Repair

Tel: +44 (0) 191 587 8739

Email: service@calibrationhouse.com

Rigel Medical

15 - 18 Bracken Hill

South West Industrial Estate

Peterlee

County Durham

SR8 2SW

United Kingdom



RIGEL MEDICAL

GMC-INSTRUMENTS GROUP

Rev 1